

Python-Drive

Installation manual



www.pythondrive.com

For the models ranging from P30-R up to P1500-G

May we take this opportunity to thank you for purchasing a **Python-Drive** flexible drive shaft assembly. Your **Python-Drive** assembly is supplied complete with all the necessary bolts, screws, washers and nuts required. Please find below instructions designed to assist you during the assembly process.

1) Transmission adaptor flange.

All fixing bolts and nuts use special double locking washers, please ensure they are used as directed below by drawing No. 1 and are tightened to the correct torque settings, as indicated by the table under drawing No. 1. Make sure that studs are screwed in with the short threaded part in the adaptor flange.

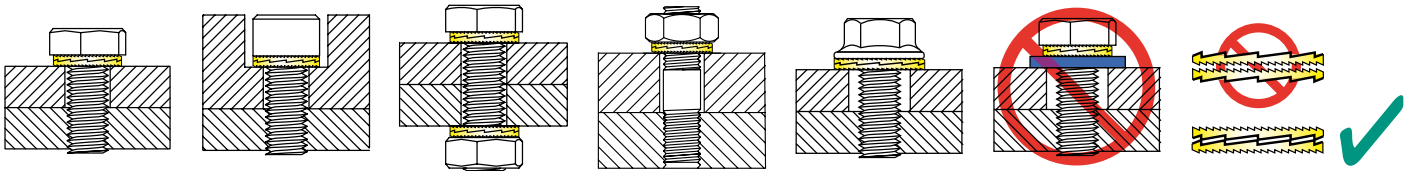

Drawing 1

Fit and tighten the bolts and nuts using following torques (the tightening torques for the internal clamps can be found separately in chapter 3 of this manual) :

	M8	3/8"UNF	M10	7/16" UNC	M12	1/2" UNC	M14	M16	M18	3/4" UNC	M20	M22	M24	1"UNC
Nm	34	58	66	83	120	125	180	280	400	500	560	750	750	1040
Lb.ft.	25	43	49	61	88	91	132	205	295	368	413	553	553	765

We would recommend that all fixing bolts, nuts and threads are free of (dust)particles and grease, prior to assembly.

2) Mounting plate

Due to the variations in hull design and material it is not possible for **Python-Drive** to supply mounting plates. We would ask you to remember, when designing a mounting plate it must be able to support the forces transmitted by the propeller. For plate dimensions refer to drawing No. 2A, 2B and 2C.

The mounting plate should be at right angles to the prop shaft both vertically & horizontally, as indicated below with drawing No. 2. Prior to positioning the mounting plate please ensure all distances have been correctly measured.

The thrust bearing assembly should be mounted on the propeller side of the mounting plate, as indicated by drawing No. 3

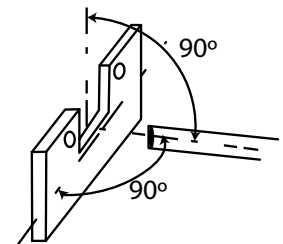

Drawing 2

Fixate the mounting plate under an angle of 90° compared to the propeller shaft as shown in drawing No. 2.

Sizes of the various mounting plates:

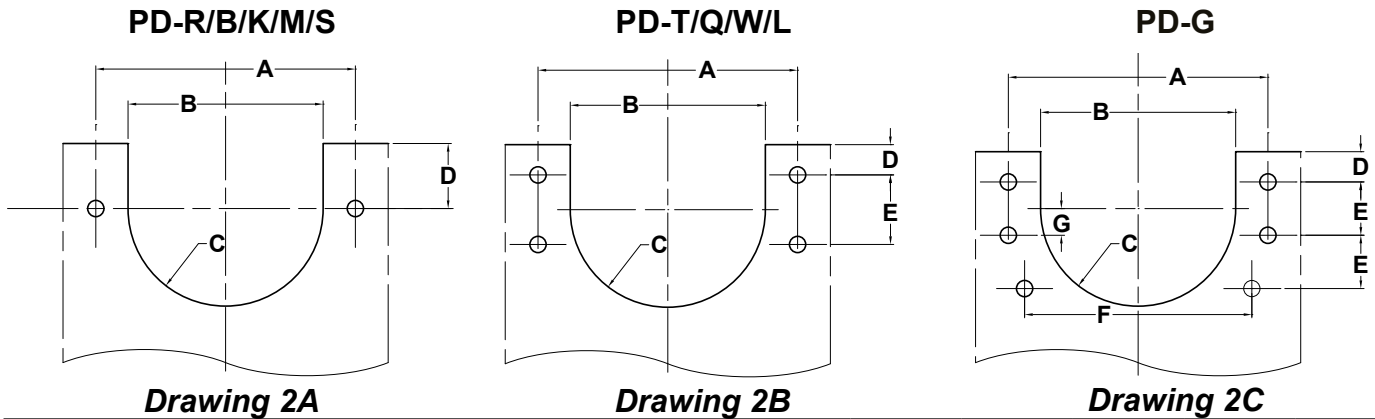

Drawing 2A	A in mm	B in mm	C in mm	D in mm	E in mm		
P30-R / PD-R	143	106	53	25	NA		
P60-B / K / PD-B / K	157	120	60	30	NA		
P80-M / S / P110-S / PD-M / S	170	140	70	35	NA		
Drawing 2B	A in mm	B in mm	C in mm	D in mm	E in mm		
P110-T / P140-T / P200-T / PD-T / P200-Q / P501-Q / PD-Q	230	184	92	40	68		
P200-W / P501-W / PD-W / P501-L / P755-L / P1025-L / PD-L	280	230	115	50	66		
Drawing 2C	A mm	B mm	C mm	D mm	E mm	F mm	G mm
P1025-G / P1500-G / PD-G	436	250	125	>50	113	384	5

Arrangement bolts, nuts and thrust-blocks

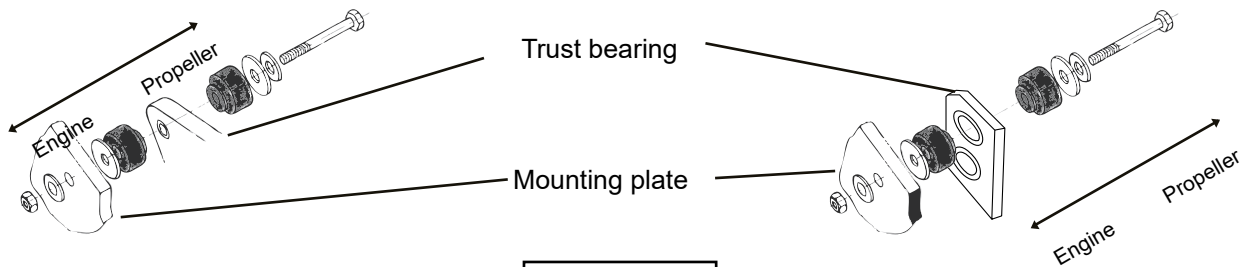

All models which carry the letter 'R', 'B', 'K', 'M', 'S' in the part No.

Drawing 3

All models which carry the letter 'T', 'Q', 'W', 'L', or 'G' in the part No.

Please Note: The thrust bearing units of all models are electrically isolated i.e. there is no metal connection between the thrust bearing unit and the mounting plate.

3) Prop shaft to thrust bearing internal clamping:

The clamping force is transmitted by contact pressure and friction between the mating surfaces, the condition of the contact surfaces and the correct tightening of the locking screws are essential. All contact surfaces including screw threads and screw head contact surfaces must be clean and slightly oiled.

Do not use oils containing Molybdenum Disulphide!

Once the ring clamp is in its correct position, tighten screws evenly in a diametrically opposite sequence by not more than half a turn per time tightening to the correct torque, as indicated by drawing No. 4.

Recheck the tightening torque by going around the screws in the sequence described until no further movement is apparent. The assembly is then complete.

The length of the prop shaft has to be determined as follows:

Mounting-surface CV joint to end of propshaft (A)

P30-R / P60-B	14 - 20 mm
P60-K	14 - 20 mm
P80-M / P80-S	16 - 20 mm
P110-S	16 - 20 mm
P110-T/P140-T	16 - 22 mm
P200-T/P200-Q	24 - 31 mm
P200-W	24 - 35 mm
P501-Q	32 - 39 mm
P501-W/P501-L	32 - 45 mm
P755-L/P1025-L	32 - 45 mm
P1025-G / P1500-G	32 - 45 mm

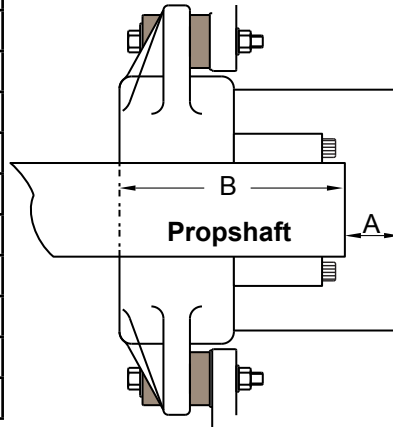

Total length of the prop shaft, which is pushed in the thrust bearing unit (B)

60 - 66 mm
90 - 96 mm
115 - 119 mm
115 - 119 mm
123 - 129 mm
144 - 151 mm
180 - 191 mm
161 - 168 mm
180 - 193 mm
200 - 213 mm
depending on execution

Drawing 4

Model	Thread / torque	Thread / torque
P30-R / P60-B	M6 - 14 Nm	
P60-K	M6 - 17 Nm	
P80-M / P80-S / P110-S / P110-T / P140-T	M6 - 17 Nm	M8 - 41 Nm
P200-T / P200-Q / P501-Q / P200-W / P501-Q	M8 - 41 Nm	M10 - 83 Nm
P501-W / P501-L / P755-L / P1025-L	M8 - 41 Nm	M10 - 83 Nm
P 1025-G / P1500-G	M12 - 145 Nm	

In applications where a prop shaft is used with a relatively small shaft diameter and this in combination with a **Python-Drive** model with a relatively high maximum torque, the unit comes with an extra clamp unit, which is inserted at the rear of the hub of the thrust bearing unit. In such cases, the installation instructions of these clamps are supplied with the clamp. Depending on the actual maximum torque, such a situation is possible, when the shaft diameter is smaller than the minimum shaft diameter as given in the leaflet.

In some cases of extremely high torque, again in combination with a relatively small shaft diameter, it is possible, that a 'Shrink Disc' will be added to the thrust bearing unit. The bolts of the 'Shrink Disc' are to be tightened with 30 Nm in the same manner as described for the internal clamps.

Removal of internal clamp:

Loosen the locking screws in a diametrically opposite sequence **P30-R / P60-B** : Remove all allen screws, then M8 bolts should be screwed in the pull out threads located under the silver-plated screws. The front ring of the clamp coupling can then be released (under normal conditions the front ring releases itself). See Fig. 1 & 2

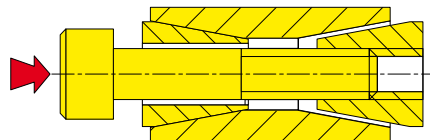

Fig. 1

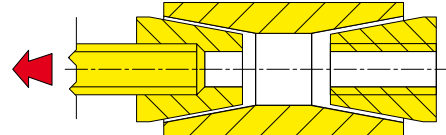

Fig. 2

P60-K / P80-M / P80-S / P110-S / P110-T / P140-T: Remove all allen screws and screw these into the release threads of the front ring, thus pressing the rear ring and release the clamp (see Fig. 3)

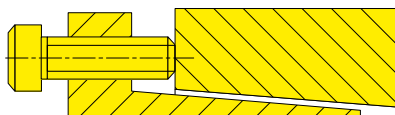

Fig. 3

P200-T up to P1025-G: remove all allen screws as previously described and screw them in the threaded bores in the front ring and release it (Fig. 4). Then screw the allen screws in the central flange and release the rear thrust ring (Fig. 5). Some of the units have a Shrink Disc coupling at the propeller-side of the thrust bearing unit, which is easily removed by simply loosening all the screws. For some applications an internal clamp coupling is used at the rear of the thrust bearing unit, which can be released in the same way as described with Fig. 3

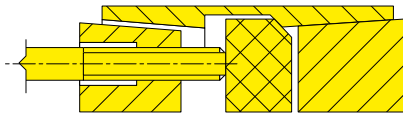

Fig. 4

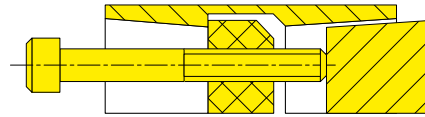

Fig. 5

4) Anti-vibration assembly:

The silent rubber blocks should be mounted as indicated in drawing No. 5.

P30-R: silent rubber blocks should be compressed to 13 mm., P60-K to 16 mm and P80-S up to P1025-L to 15 mm. as indicated in drawing No. 5

Please note : should the mounting plate not be at right angles to the prop shaft, adjustment is possible by shimming between the rubber blocks and the mounting plate.

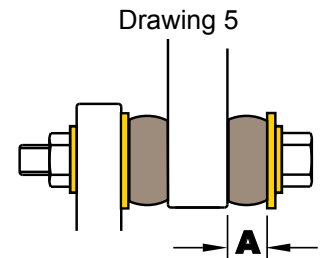

Model PD-G / P1025-G has polyurethane thrust blocks, where the above described 'compression' does not apply, but shimming may be necessary.

5) Drive shaft lengths and angles:

We recommend the flexible drive shaft installation lengths and angles are thoroughly checked. This procedure is important, due to the movement that may be inherent within the installation. Where engines are mounted on flexible mounts, there is always a tendency for the installation to move fore and aft, in addition to port and starboard. Allowing for **plus or minus 2 mm.** the net length of the flexible drive shafts of the models from P30-K to P140-T and for **plus or minus 3 mm.** for P200 and P501, can be taken from the drawings attached to this manual (these dimensions = L as indicated in drawing No. 6). For model P755, P1025 also see these drawings (allowing for **plus or minus 12 mm.**), see last pages of this manual. A simple way to determine the actual length is to measure both the longer side and the shorter side and to average them out. This must be the length of the flexible shaft you have chosen. If the location points are out in more than one plane, measure both planes as previously described and average the two sets of figures, as indicated by drawing No. 6 and No. 7

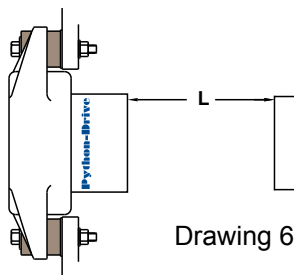

Drawing 6

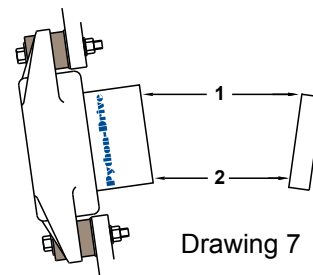

Drawing 7

The P30 up to the P110 drive shafts have coloured 'O' rings which hold the boot covers in place. The P140 has clamps which hold the boot cover of the CV joint in place, where one has a coloured tag to identify the net length of the CV drive shaft. The meaning of the colours is as follows:

P30/60/80-145 mm	WHITE	standard length for P30-R and P60-B
P30/60/80-165 mm	BLUE	standard length for P60-K
P30/60/80-195 mm	BLACK	standard length for P80-S
P110-180 mm	YELLOW GREEN	standard length
P140-180 mm	BLACK	standard length

Tip: Measuring of the length of **Python-Drive** CV drive shafts where models P200 and larger fit in recesses in the hub and the adaptor flange

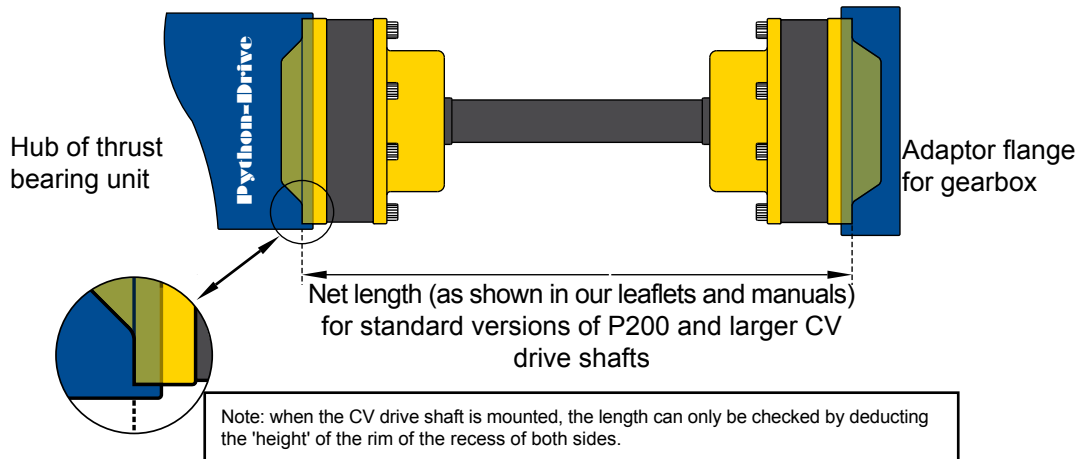

Important; we recommend that the drive shaft “constant velocity” joint angles at either end of the shaft are installed correctly. Under no circumstance should a **Python-Drive flexible drive shaft be installed at Zero angles (in line). To do so will greatly shorten the life of the CV joint, causing premature failure due to a loss of bearing efficiency/lubrication. A minimum of 1.5° per joint is recommended.**

The **maximum angle** of installation of the **Python-Drive** CV joint and the maximum operating propshaft RPM is as indicated by chart No. 8

maximum angles and maximum propshaft RPM			
	P30 - P140	P200 – P1025	
8°	0 - 1000 rpm.	4°	1200 rpm.
7°	1500 rpm.	3.5°	1500 rpm.
6°	2000 rpm.	3°	1750 rpm.
5°	2500 rpm.	2.5°	2250 rpm.
4°	3500 rpm.	2°	3000 rpm.
3°	4500 rpm.		

Chart No. 8

Ideally the CV joints should be mounted at approximately the same angle. If this is not possible **and** the difference between the angles of the front and rear CV joint would be greater than 5°, the CV-joints could become subject to abnormal loads, maybe resulting in premature wear.

Drawing No. 9 shows the ideal set-up and drawing No.10 shows a less ideal set-up.

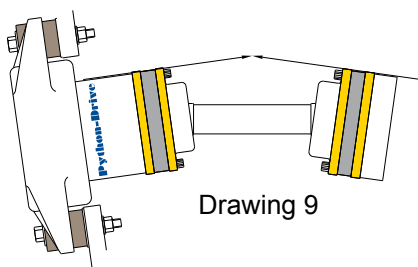

Drawing 9

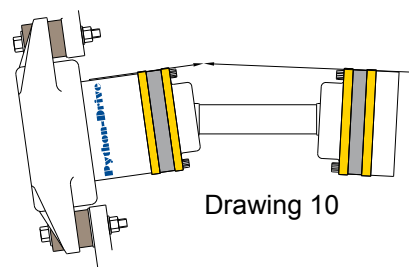

Drawing 10

CV Drive shaft assembly:

Fit the shaft into place loosely, ensuring the threads of both sets of bolts are engaged as to the tightening procedure. Proceed to tighten the bolts in a diametrically opposite sequence to the correct torque, as indicated in the table under drawing No.1

Please note: All P755, P1025 models require filling with grease, (see under 7 below), which is supplied in the parcel.

6) Python-Drive maintenance:

- All thrust bearing units are maintenance-free as they have life-time lubrication.
- The following CV joints are supplied with lifetime lubrication and are therefore maintenance free: P30, P60, P80, P110, P140, P200, P501.
- All P755, P1025 models require filling with grease prior to being installed in the boat.
Grease is supplied as part of the kit, and should be filled flush with the top surface of the CV joints.
Too much grease will automatically result in leakage causing the excess grease to be thrown out by the centrifugal force.
Insufficient grease will cause premature failure due to lack of lubrication. When servicing, always ensure you use the correct specification grease to Total CERAN XM 220 (ISO 6743-9: L-XBFIB 1/2), (DIN 51 502: KP1/2R-30).

7) Assembly checks:

- Ensure all washers are correctly located.
- Check studs, bolts and nuts are tightened to the correct torques (use a torque wrench!)
- Check required shaft lengths
- Check installation angles
- Check clamping surfaces are free of knocks or damage, which may prevent a face to face contact.
- Check for surface damages of the drive / thrust assembly
- Check the adjustment of the flexible engine mounting feet; as manufacturers use different instructions for their own make of mounts. Most manufacturers will allow you to pair wise adjust the load/compression of the left and right flexible engine mounting feet between 0 to 1 mm. Some manufacturers however won't allow for any differences. Check both front and rear pairs.
- **Prior to engine start up ensure the prop shaft rotates by hand and that all tools have been removed.**
- **It is essential that the engine, gearbox, torsional damper, propeller size and Python-Drive model are correctly matched, so that the engine can attain its rated speed appropriate to the relevant service classification without labouring.**
- **It is also important to ensure the torsional compatibility of the complete propulsion system from engine through to propeller, since disregarding this may result in gear noise. In addition, it may result in damage to the engine as well as to drive line components.**

The manufacturer of **Python-Drive** will provide all possible information and assistance to help find solutions to potential torsional problems. However, it is the ultimate responsibility of the person assembling the drive and driven equipment to ensure that they are torsionally compatible.



Type	P30-R
Maximum shaft torque	30 kgm
	294 Nm
Propeller shaft diam.	19 - 30 mm
Maximum prop. thrust	4.3 kN
Example use with diesel engine	50 HP / 3000 rpm 2.5:1 gearbox
CV drive shaft optional lengths	145, 165 or 195mm.

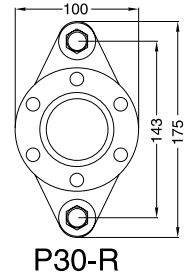
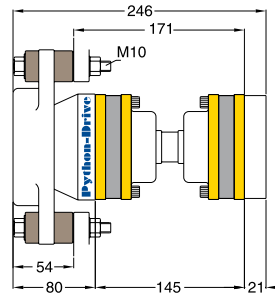

P30-R

Type	P60-B
Maximum shaft torque	60 kgm
	588 Nm
Propeller shaft diam.	1.25" - 40 mm
Maximum prop. thrust	5.7 kN
Example use with diesel engine	70 HP / 2600 rpm 3:1 gearbox
CV drive shaft optional lengths	145, 165 or 195mm.

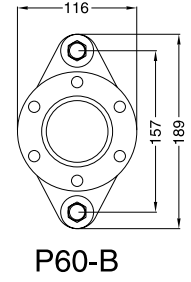
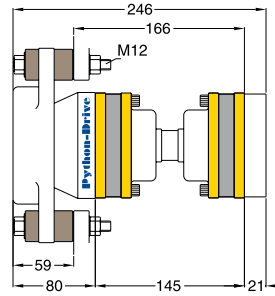

P60-B

Type	P60-K
Maximum shaft torque	60 kgm
	588 Nm
Propeller shaft diam.	30 - 40 mm
Maximum prop. thrust	5.7 kN
Example use with diesel engine	70 HP / 2600 rpm 3:1 gearbox
CV drive shaft optional lengths	145, 165 or 195mm.

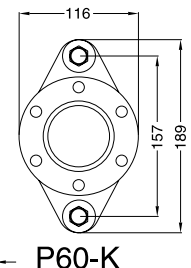
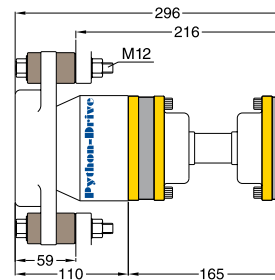

P60-K

Type	P80-M
Maximum shaft torque	80 kgm
	785 Nm
Propeller shaft diam.	30 - 45 mm
Maximum prop. thrust	8 kN
Example use with diesel engine	105 HP / 3000 rpm 3:1 gearbox
CV drive shaft optional lengths	145, 165 or 195mm.

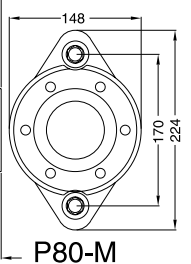
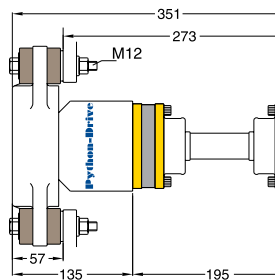

P80-M

Type	P80-S
Maximum shaft torque	80 kgm
	785 Nm
Propeller shaft diam.	30 - 45 mm
Maximum prop. thrust	12 kN
Example use with diesel engine	130 HP / 2400 rpm 2:1 gearbox
CV drive shaft optional lengths	145, 165 or 195mm.

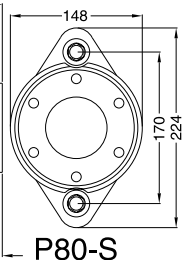
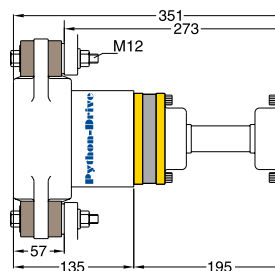

P80-S

Type	P110-S
Maximum shaft torque	110 kgm
	1.080 Nm
Propeller shaft diam.	35 - 45 mm
Maximum prop. thrust	12 kN
Example use with diesel engine	135 HP / 2700 rpm 3:1 gearbox

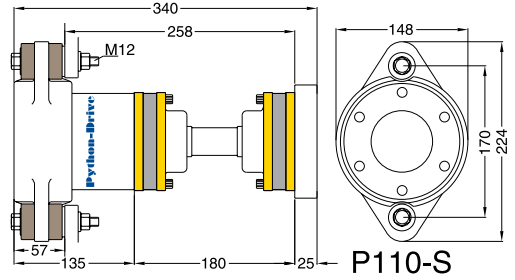

Type	P110-T
Maximum shaft torque	110 kgm
	1.080 Nm
Propeller shaft diam.	35 - 45 mm (2")
Maximum prop. thrust	18 kN
Example use with diesel engine	180 HP / 2400 rpm 2:1 gearbox

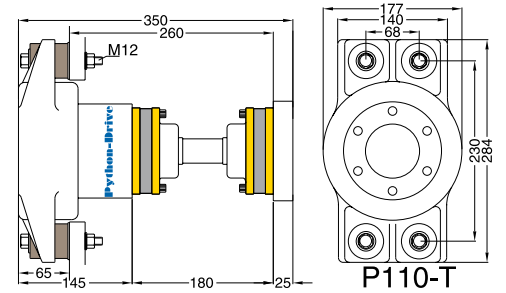

Type	P140-T
Maximum shaft torque	140 kgm
	1.370 Nm
Propeller shaft diam.	40 - 55 mm
Maximum prop. thrust	18 kN
Example use with diesel engine	190 HP / 2500 rpm 2.5:1 gearbox

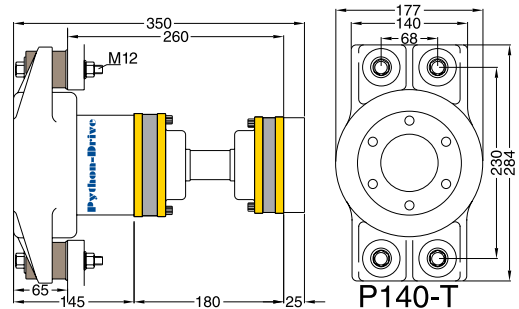

Type	P200-T
Maximum shaft torque	200 kgm
	1.960 Nm
Propeller shaft diam.	40 - 60 mm
Maximum prop. thrust	18 kN
Example use with diesel engine	240 HP / 2300 rpm 2.5:1 gearbox

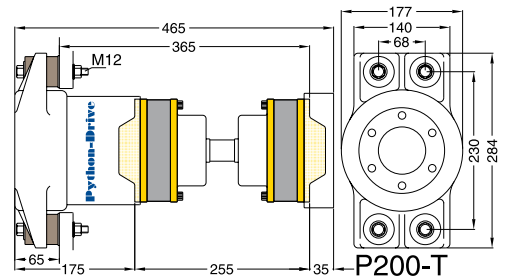

Type	P200-Q
Maximum shaft torque	200 kgm
	1.960 Nm
Propeller shaft diam.	45 - 60 mm
Maximum prop. thrust	22 kN
Example use with diesel engine	250 HP / 2800 rpm 3:1 gearbox
Recommended rpm PD-Q thrust unit	Max. 1500 rpm

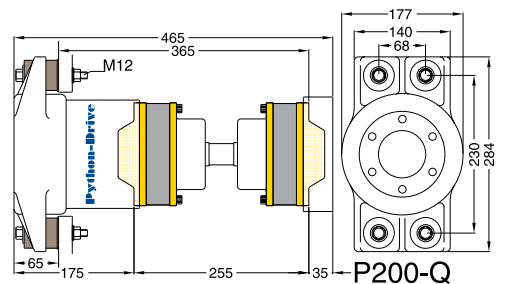

Type	P200-W
Maximum shaft torque	200 kgm
	1.960 Nm
Propeller shaft diam.	50 - 60 mm
Maximum prop. thrust	30 kN
Example use with diesel engine	275 HP / 2500 rpm 2.5:1 gearbox

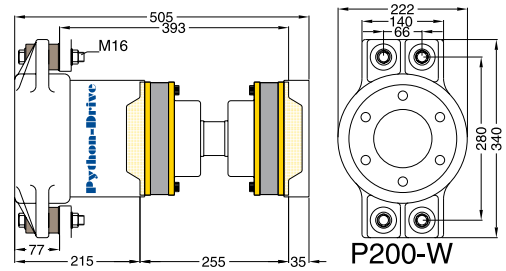

Type	P501-Q
Maximum shaft torque	500 kgm
	4.900 Nm
Propeller shaft diam.	50 - 60 mm
Maximum prop. thrust	22 kN
Example use with diesel engine	300 HP / 2000 rpm 3:1 gearbox
Recommended rpm PD-Q thrust unit	Max. 1500 rpm
CV drive shaft optional lengths	221 or 260 mm

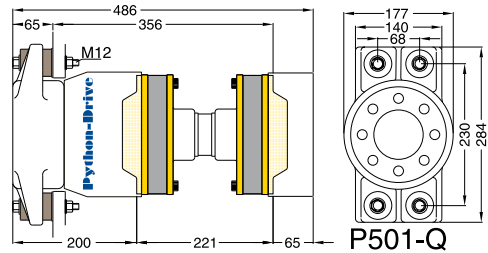

Type	P501-W
Maximum shaft torque	500 kgm
	4.900 Nm
Propeller shaft diam.	50 - 80 mm
Maximum prop. thrust	30 kN
Example use with diesel engine	400 HP / 2200 rpm 3:1 gearbox
CV drive shaft optional lengths	221 or 260 mm

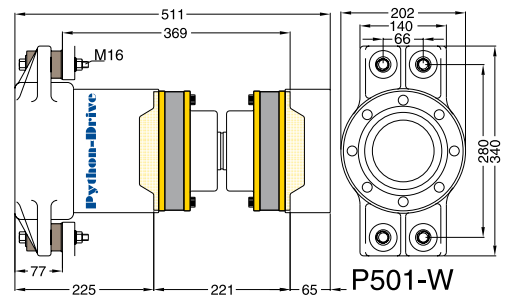

Type	P501-L
Maximum shaft torque	500 kgm
	4.900 Nm
Propeller shaft diam.	50 - 80 mm
Maximum prop. thrust	45 kN
Example use with diesel engine	500 HP / 2200 rpm 3:1 gearbox
Recommended rpm PD-L thrust unit	Max. 1500 rpm
CV drive shaft optional lengths	221 or 260 mm

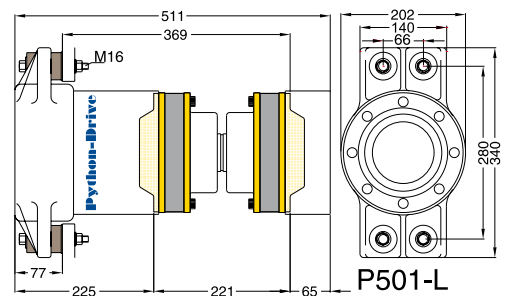

Type	P755-L
Maximum shaft torque	750 kgm
	7.355 Nm
Propeller shaft diam.	70 - 80 mm
Maximum prop. thrust	45 kN
Example use with diesel engine	600 HP / 2200 rpm 3:1 gearbox
Recommended rpm PD-L thrust unit	Max. 1500 rpm

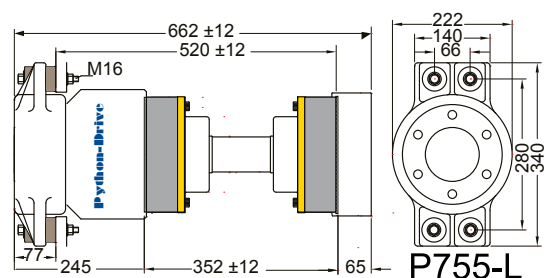

Type	P1025-L
Maximum shaft torque	1000 kgm 9.810 Nm
Propeller shaft diam.	70 - 80 mm
Maximum prop. thrust	45 kN
Example use with diesel engine	750 HP / 2000 rpm 3:1 gearbox
Recommended rpm PD-L thrust unit	Max. 1500 rpm

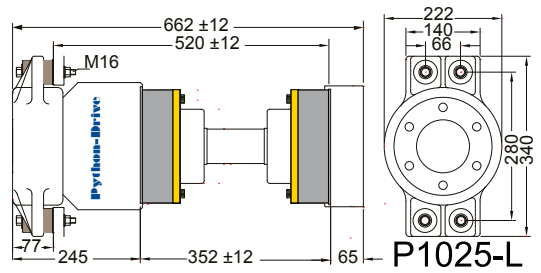

Type	P1025-G
Maximum shaft torque	1000 kgm 9.810 Nm
Propeller shaft diam.	70 - 100 mm
Maximum prop. thrust	60 kN
Example use with diesel engine	800 HP / 1900 rpm 3:1 gearbox
Recommended rpm PD-G thrust unit	Max. 1500 rpm

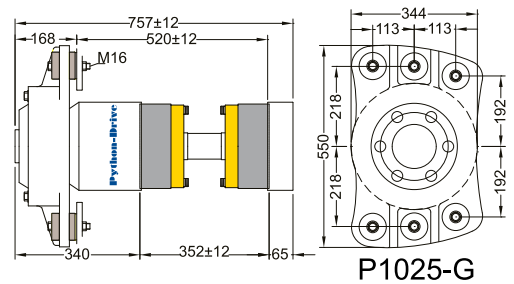

Type	P1500-G
Maximum shaft torque	1500 kgm 14.715 Nm
Propeller shaft diam.	80 - 100 mm
Maximum prop. thrust	60 kN
Example use with diesel engine	950 HP / 1900 rpm 3:1 gearbox
Recommended rpm PD-G thrust unit	Max. 1500 rpm

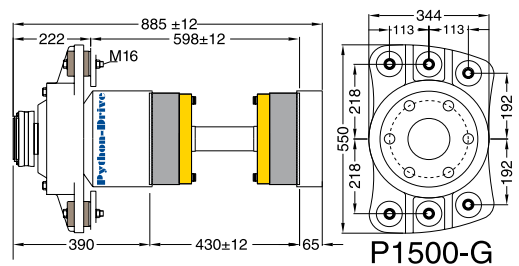

- A. Bearing housing
- B. Thrust bearing
- C. Thrust rubbers
- D. Hub
- E. Internal clamp
- F. CV joint thrust bearing side
- G. Intermediate shaft
- H. Boot kit
- I. CV joint gearbox side
- J. Gearbox adaptor flange
- K. Propeller shaft

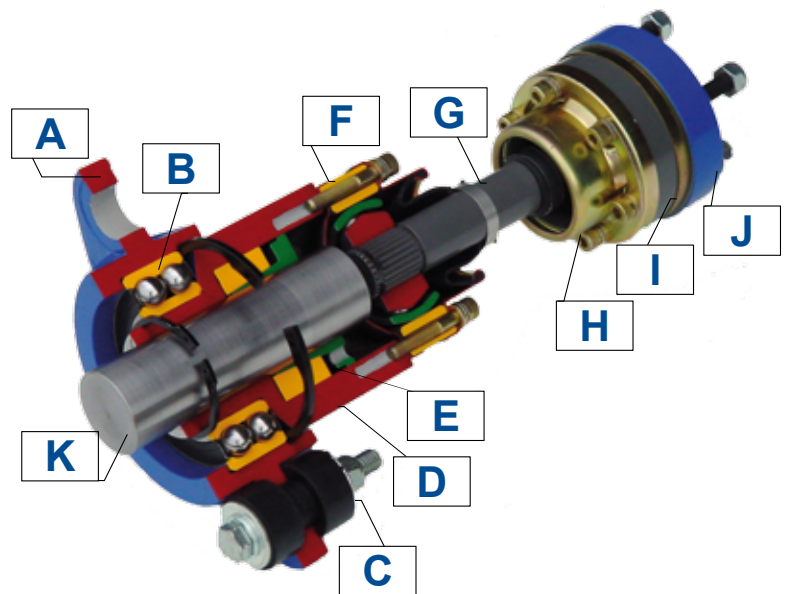

Above mentioned **Python-Drive** units are supplied complete with CV-drive shaft, thrust bearing unit, adaptor flanges for most regular 4", 5", 5.75" and 7.25" gearbox flanges, all bolts, nuts, thrust-rubbers and lock washers. Also included is an easy to read **INSTALLATION MANUAL**.

